

Quick Fit Adaptor

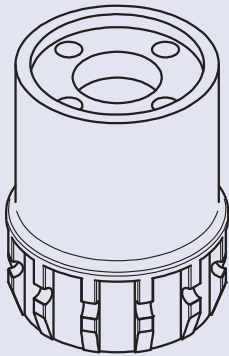

Designed for

- Easy installation
- Fix the windlass to the deck and simply slip the motor and gearbox into position
- Strong stainless steel construction
- Easy to remove the motor and gearbox for maintenance, simply remove 1 bolt and the quick fit retaining clip and the motor and gearbox assembly slides off
- Standard supply on 600 / 850 / 1250 / 2200 Storm models
- Positions available for 360° rotation of motor / gearbox.



ADAPTOR

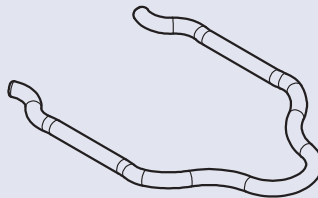

CLIP

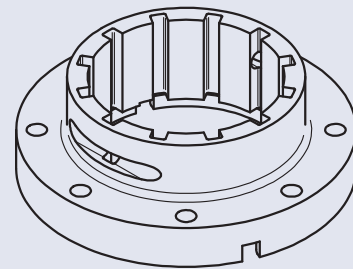

BASE PLATE

Quick Fit Assembly/Disassembly

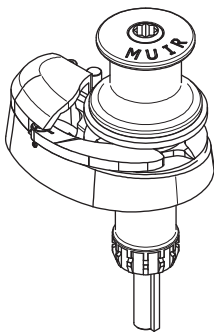

Fig. 1

Top unit assembly as received by customer.

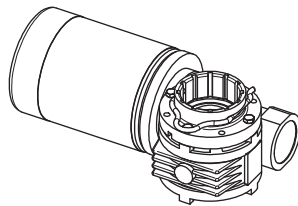

Fig. 2

Bottom unit assembly as received by customer.

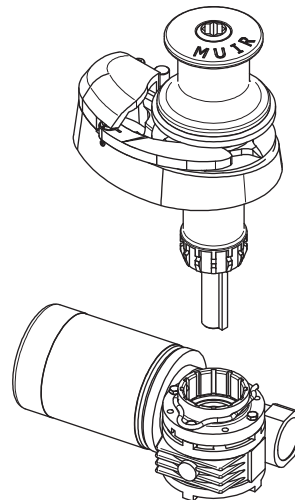

Fig. 3

Align motor and gear box for your required position then slide up shaft until spring retains gear box mount.

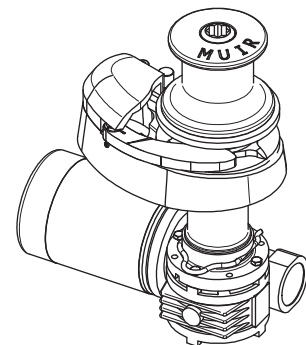

Fig. 4

Bolt retaining washer to end of drive shaft to complete the finished unit.